

9、Temporary password

- Temporary password can be created and deleted through app. After each create or delete is completed on the app, the lock hardware is required to synchronize with the server.
- At the time of creation, you can choose whether to send SMS or not. Worldwide SMS is supported.

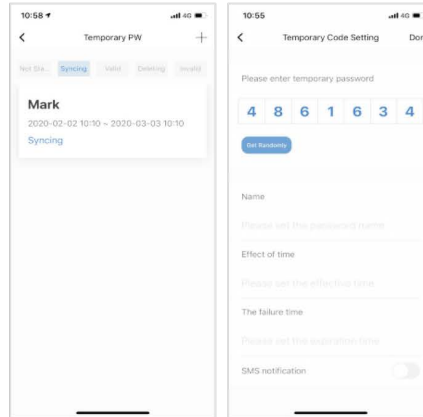

10、Hijacking alarm

- When the anti-hijacking mark in the left picture is opened, if the unlock action of the unlock ID occurs, the record will report and the app will trigger the anti-hijacking alarm

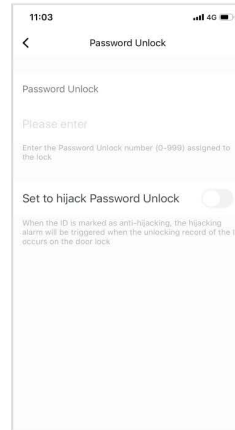

11、Factory Data Reset

- Click the icon in the upper right corner of the main interface. Find the Factory Data Reset and click.
- The Factory Data Reset can also be operated on the lock. Please refer to the instruction manual for details.

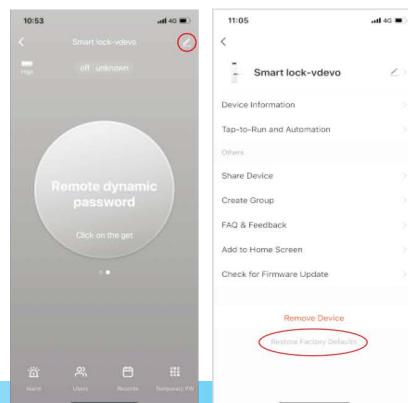

FINGERPRINT DOOR LOCK

user manual



INSTALLATION GUIDE

Accessory

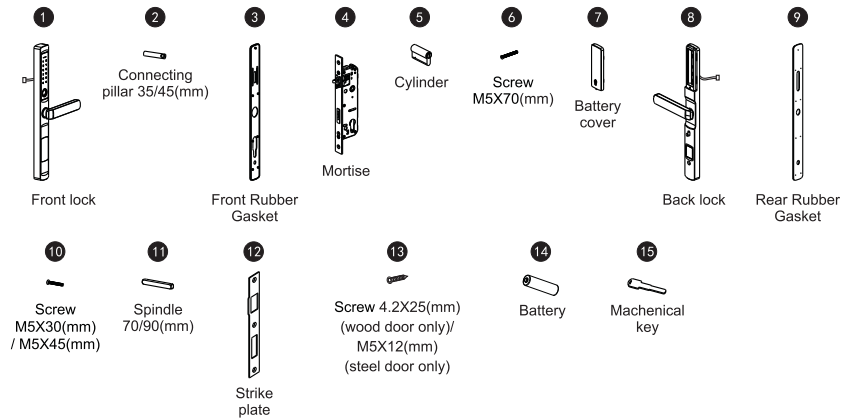

Door opening direction

① Right handle opening

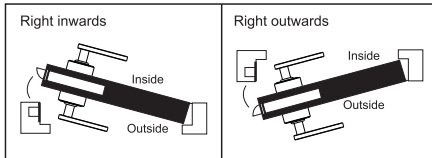

② Left handle opening

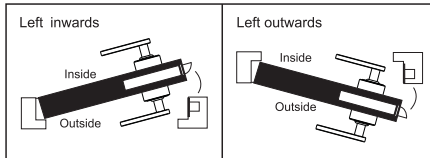

Adjust the mortise direction

According to the your need to adjust the mortise direction.

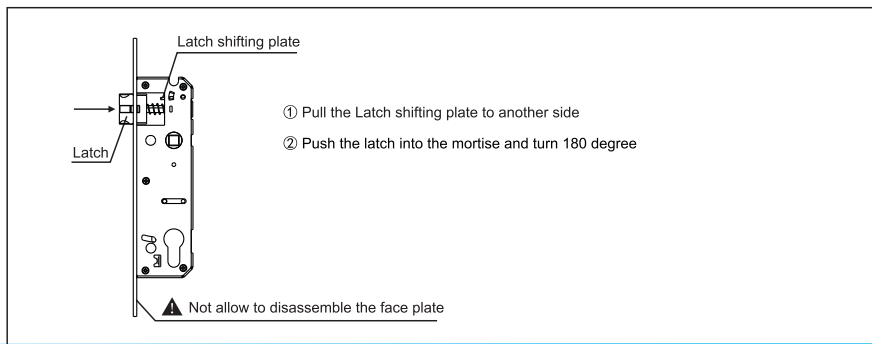

Switch Left Handle and Right handle

According to your opening direction, loose the screw inside the handle with a Philip screw driver, and pull out the handle, then turn to the correct direction that you want, then fix the screw inside the handle.

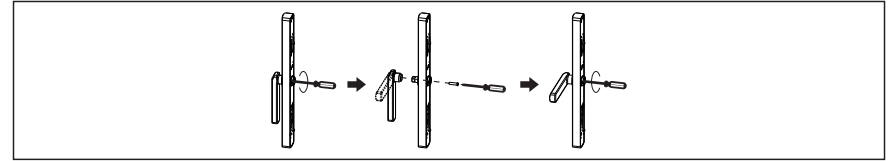

Right Handle

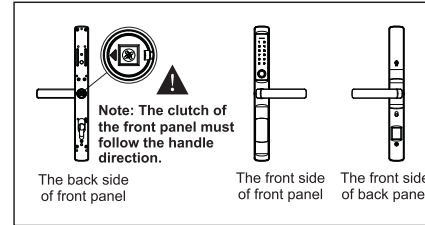

Left Handle

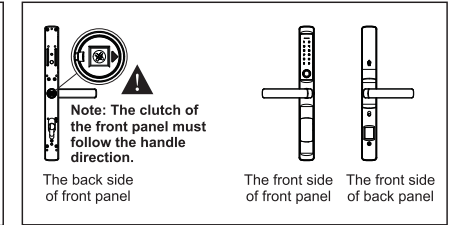

Accessories for sorts of door thickness

Available door thickness 35mm-70mm. If the door is over this range, please contact us for more information. Please select the correct accessories according to your door thickness.

Code and name	Specifications(mm)	door thickness ranges & QTY	
		35-50(mm)	50-70(mm)
① Spindle 70/90(mm)	70	1	
	90		1
⑬ Screw 4.2X25(mm) (wood door only)	25 4.2	5	5
⑬ Screw M5X12(mm) (steel door only)	12 M5	5	5
⑩ Screw M5X30(mm) / M5X45(mm)	30 M5	1	
	45 M5	1	2
② Connecting pillar 35/45(mm)	35	2	
	45		2

Caution before installation

- Do not be a strong force when installation, avoid to damaging the lock.
- Use correct installation tools.
- Wear glass to protect your eyes when drilling holes.
- Drilling the door holes on both side of the door avoiding to damaging the door plate.

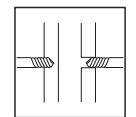
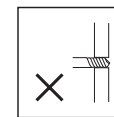
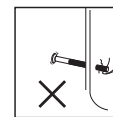

Installation

Installation steps:

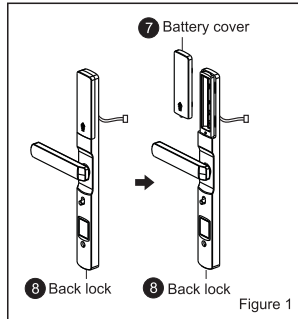

Figure 1

(1) As Figure 1:

- ① Divide the Back Lock into Battery cover and Back panel.

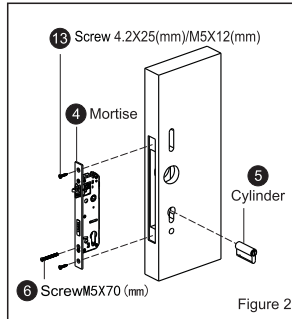

Figure 2

(2) As Figure 2:

- ① Make the mortise cable get through the door plate, fix the mortise with 2 screws.

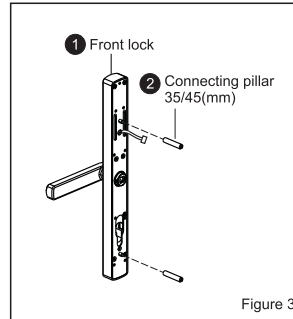

Figure 3

(3) As Figure 3:

- ① Install the two connecting pillars with the front lock.

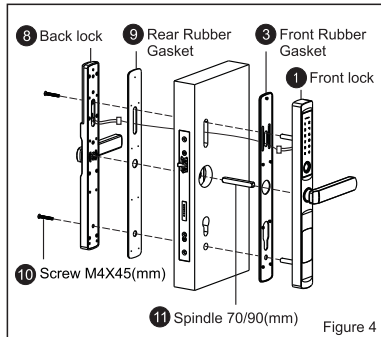

Figure 4

(4) As Figure 4:

- ① Insert the spindle into mortise.
- ② Make the front body cable through the front rubber gasket, door plate and rear rubber gasket, can connect to the rear body.
- ③ Fix the rear body and front body with two screws.

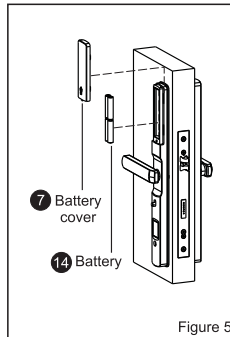

Figure 5

(5) As Figure 5:

- ① Put the Batteries correctly and fix the Battery cover.

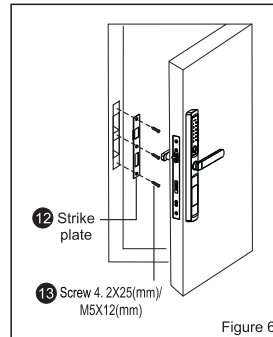

Figure 6

(6) As Figure 6:

- ① Fix the fix the strike plate with 3 screws on the door frame.

Check points after installation

- ① The face plate is horizontal with the door.
- ② The Latch bolt and Dead bolt must works smoothly and flexibly.
- ③ The Front lock is vertical and stable.
- ④ Front handle works smoothly and flexibly, Dead bolt should be in position when you lift the handle.
- ⑤ Dead bolt should be in position when you lift the Back handle, and it should be retracted when you press the handle.

Intelligent lock(five in one) operation manual

1. Function and Operation

1.1 Description of terms and functional keys

- 1) Administrator information: refer to the Administrator's fingerprint, password or IC card.
Unlock information: refer to the input fingerprint, password, Remote control or IC card information (including Administrator and ordinary users).
- 2) Key"*": clear key/back key. Enter the password or point by clearing the previous input. Press the clear key three times in succession, empty all input.
- 3) Key"#": confirmation key or menu function key.

2. Original state

- 1) The factory administrator or initial password is 123456, under the or initial state any fingerprint, IC card or password can open the lock.
- 2) Any fingerprint, IC card, or password which are not registered can't open the lock after inputting the administrator information.

3. Lock function management (step one)

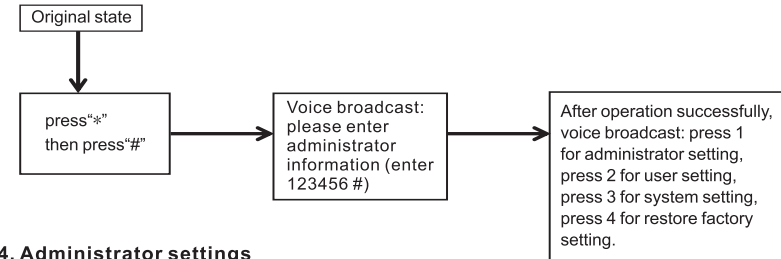

4. Administrator settings

1) Add administrator (step 2)

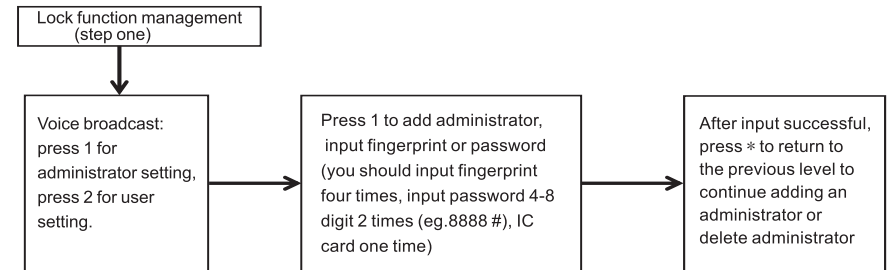

2) Delete administrator information

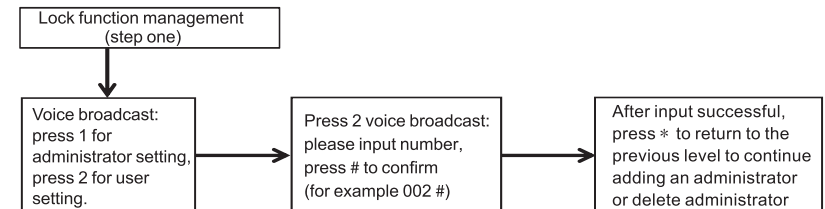

5. Common user setting

1) Add User information

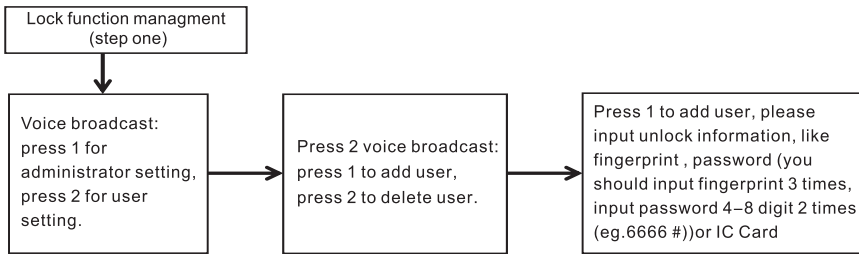

2) Delete user information

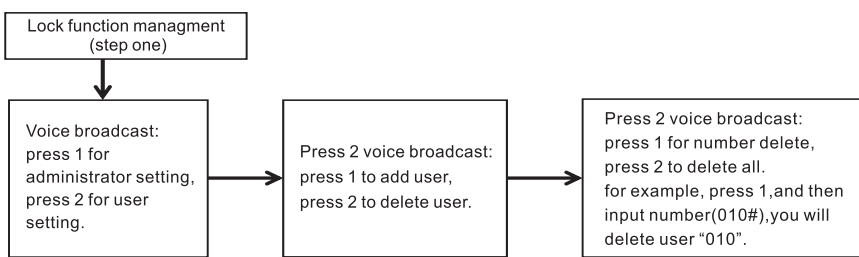

6. system setting

1) Voice setting

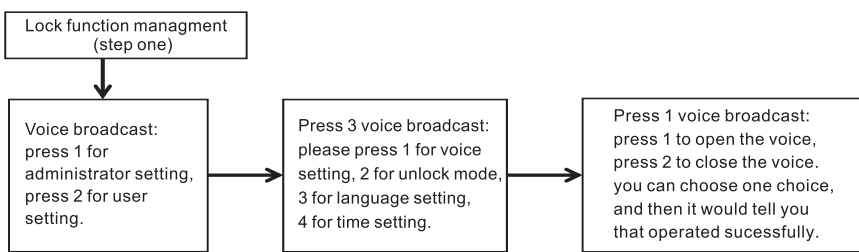

2) Unlock mode setting

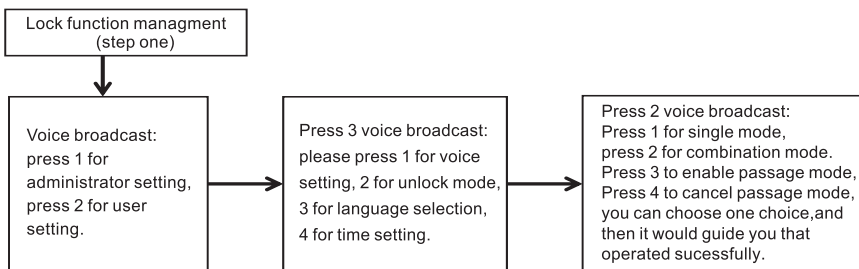

3) Language settings

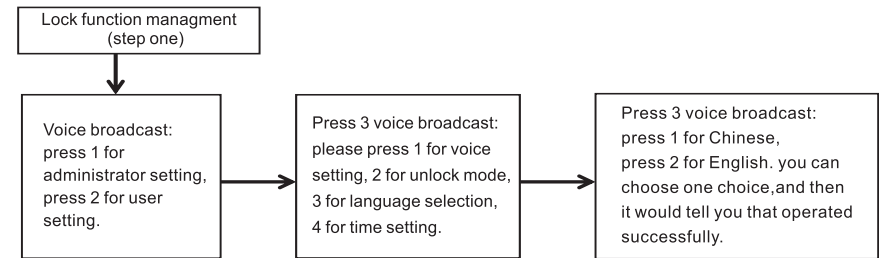

4) Time setting

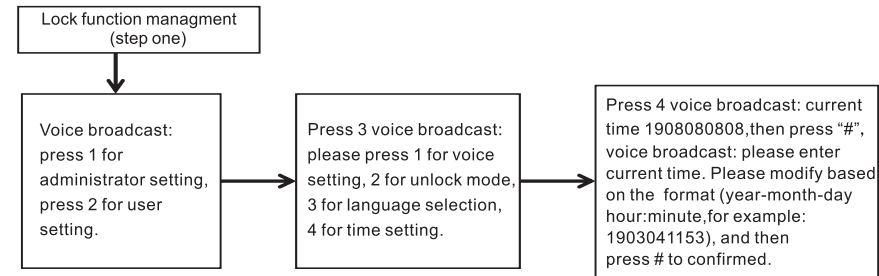

7. Restore factory settings

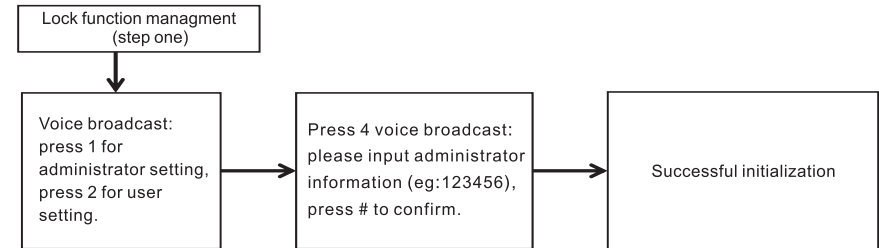

8. APP Configuration (Tuya Smart) - optional

- 1) Search "Tuya Smart" in App Store or an App market, download and install it.
- 2) Register with your cellphone number and log in.
- 3) Click "Security & Sensor", find "Lock(Wi-Fi)", click and add a device following instructions before use.
- 4) Remote unlocking: wake up the screen and press "9"+"#". There will be a voice prompt: requesting remote unlocking.

Add one network

- 1) Press "*"+"#" to authenticate administrator identity and then press "1" to access administrator settings. Then there will be a voice prompt of pressing "3" for network configuration.



Intelligent lock(five in one) operation manual

2) Voice prompt in network configuration mode: press "1" for hotspot connection and "2" for intelligent connection.

3) When the network is successfully added, the 1st, 2nd, 3rd and 4th lights on the keyboard will be on in order with a voice prompt of "operation completed".

4) In the event of network addition failure, the 1st, 2nd, 3rd and 4th lights on the keyboard will not be on and there will be a voice prompt of "operation failed" upon timeout.

Notice:

Please add administrator before setting.

9. Other notes

1) Input the wrong password more than 5 times in a row, the keyboard locked for 30 seconds, it does not respond to any operations in 30 seconds.

2) Password peeping prevention function: input password as follows when opening the door with password: XXX password XXX; you can add some extraneous codes before and after the password, and then press # to confirm. The password must be included in the input contents.

3) If there is no operation more than 10 seconds, system will automatically exit.

4) After the voltage is lower than 4.6v, the lock will automatically alarm every time when it is opened. After the alarm, the lock can be opened for about 200 times.

5) Remove the battery cover, press the "Set" key for 6 seconds, the lock was restored to factory mode;

6) In factory mode, input "333666999#" can change the language quickly;

7) When unlocking, input "5#" to enter passage mode (One time effective);

8) When unlocking, input "*" to broadcast the user number;

Technical Parameters

Technical Parameters			
	Items	Parameters	Memo
1	Static current	≅ 50uA	
2	Dynamic current	≅ 180mA	
3	Administrators number	9	
4	Fingerprint number	100	
5	Fingerprint + password + card capacity	300	
6	Fingerprint Sensor	Semiconductor	
7	Fingerprint contrast time	≅ 0.6Second	
8	Fingerprint identification Angle	360°	
9	False Rejection Rate	≅ 0.1%	
10	False Recognition Rate	≅ 0.0001%	
11	Reaction time	≅ 0.1 Second	
12	Power type	6V	
13	Emergency power	5VDC	
14	Working temperature	-25℃~60℃	
15	Working Relative Humidity	20%~90%RH	
16	Human voice	Yes	
17	Keyboard	Touch standard 12-bit keyboard	
18	Password Length	4-8 digits	
19	Phantom password	32 digits	
20	Low voltage alarm	4.6±0.2V	
21	Unlock time	≅ 1Second	

Smart lock manual

Main function modules

1、APP registration and login

- APP registration: if you do not have an APP account, you can choose to register or log in by SMS verification code.
- Click "create a new account" to enter the account registration page. According to the prompt to obtain SMS verification code, set the password.
- If you have an existing account, click "login with an existing account" to log in to the APP. Password, verification code, and social account login are supported.

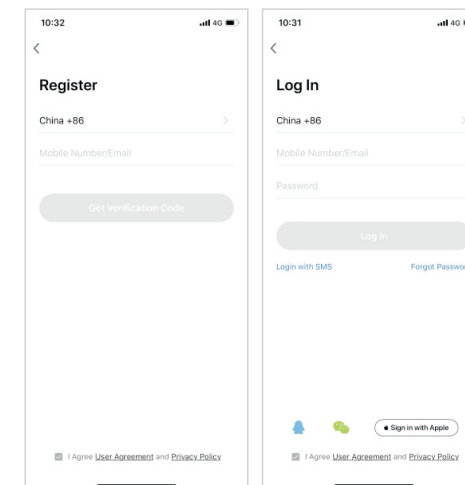

2、Create Homes

- Create your home after registering and logging in successfully.
- Each account can create and add multiple homes, and devices can be grouped by room in the home.
- Weather and other functions depend on the geographical location of the family, which is recommended to set in advance.

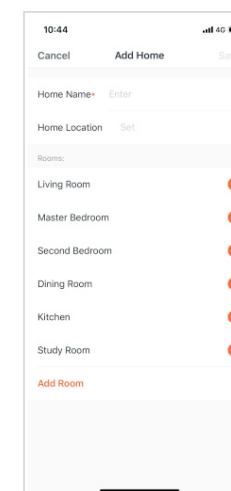

3. Add WiFi lock

- On the Tab of "my home", click "+" in the upper right corner to enter the interface in figure 1, select the WiFi door lock in security sensor part and enter the page in figure 2.
- When the device enters the connected mode, continue to operate according to the instructions and APP tips.

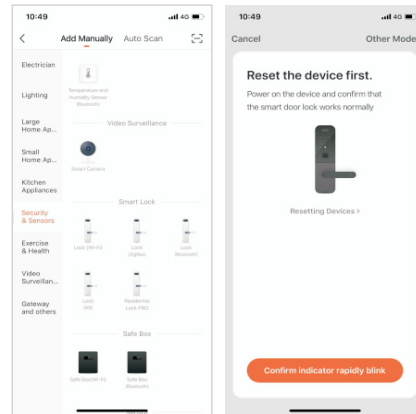
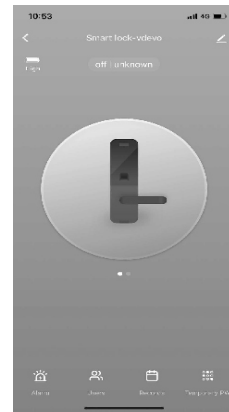

Figure 1

Figure 2

4. Home Page

- Home page includes remote unlock, alarm message, member management, record, temporary password and other functions.
- Remote Unlock: initiate a request from the door lock, and the app can respond to allow / refusal door opening



5. Dynamic password

- Click to get the dynamic password Meanwhile copy the password text for you

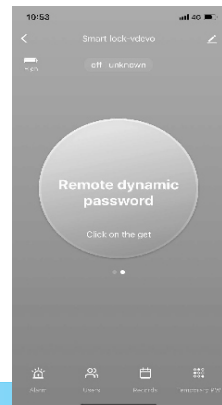

6. Message center

- Message center contains alarm information, doorbell call information and hijacking alarm information, which can be inquired.

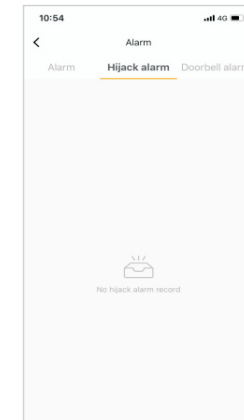

7. User Management

- User can be added, deleted or changed in member management. Only the administrator user of app is allowed to do that.

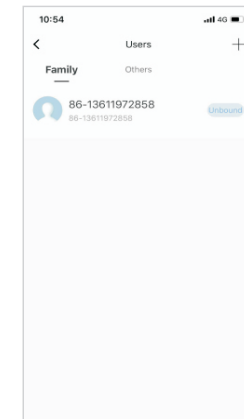

8. Record Log

- 24/7 Record Log, arranged in reverse chronological order. The unlocked ID with the associated user name will directly display the user name, while the unlocked ID without the associated name will display the specific unlock ID

