

# Keliss

---

Dear customer:

Thank you for choosing Keliss Smart Mirror!

Embed with exquisite workmanship and engineering techniques, based on high-quality standards of production, Keliss Smart Mirror thrives in the modern smart home industry. However, the products still need certain care and maintenance for a better user experience.

How to clean a mirror?

1. Dip a piece of lint-free cloth with warm water and wring it out, wipe the mirror surface, and then wipe out the remaining water with another piece of dried cloth.
2. Do not spray the cleaners directly on the mirror, simply apply it to the cloth or mix it with the warm water.
3. Use neutral cleaners instead of acid or alkali ones, also avoid using abrasive cleaners which can cause damage to all parts of a mirror.

Note: The cleaners should not include ammonia.

If you follow all the simple procedures above, your smart mirror will always look stunning as brand-new!

Sincerely,  
Keliss



# Keliss

---

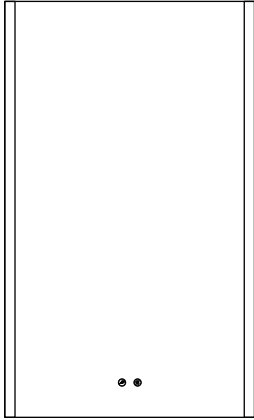

MTS4XXXXDS

Vertical and horizontal mount options

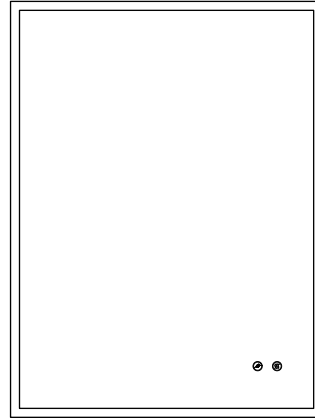

MTS2XXXXDS

Vertical and horizontal mount options

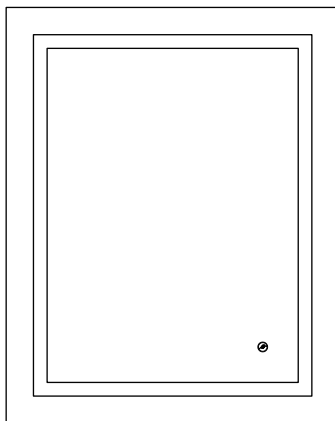

MTS0XXXXSS

Vertical and horizontal mount options

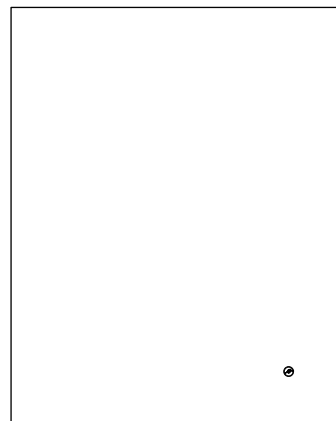

MTS5XXXXSS

Vertical and horizontal mount options

# LED MIRROR INSTALLATION GUIDE



**Please read the information below before using**



**WARNING** To reduce the risk of burns, fire, electric shock, or injury to people, please use this furnishing only for its intended purpose as described in these instructions.

Do not use any attachments that are not recommended by the manufacturer.



**WARNING**

Never drop or insert any objects into any of the openings.

This product is for indoor use only and should not be used outdoors.

Risk of electric shock. Connect this furnishing to a properly grounded circuit only. See Grounding instructions.



**WARNING GROUNDING INSTRUCTIONS:**

This product must connect to a grounded metal, permanent wiring system, or an equipment-grounding conductor must run with the circuit conductors and be connected to the equipment-grounding terminal or lead on the product.

An electrical option cabinet must be wired to a 20 Amp GFI (Ground Fault Interrupter) protected circuit when used in bathrooms and all other locations required by the National Electric Code.

PLEASE SAVE THIS USER MANUAL FOR FUTURE REFERENCE

# LED MIRROR INSTALLATION GUIDE



## TOOLS REQUIRED FOR ASSEMBLY

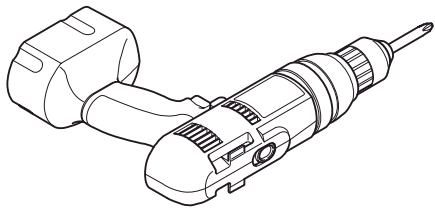

Electrical Drill

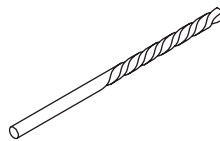

1/8" Drill Bit

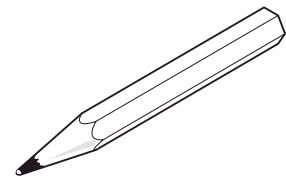

Pencil



Phillips  
Screwdriver

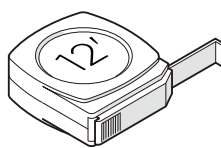

Tape Measure

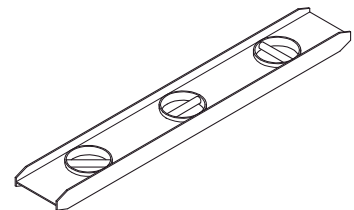

Level

## PARTS INCLUDED

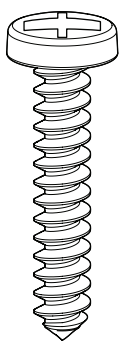

SCREW  
(x4)

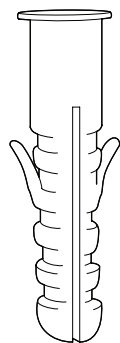

WALL PLUG  
(x4)

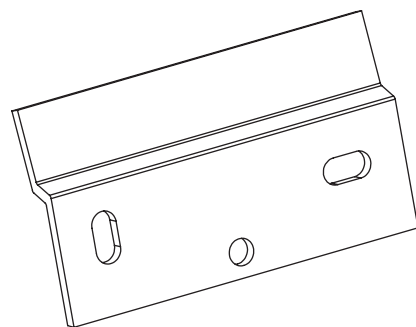

WALL HANGER  
(x2)



**NOTE:** Determine overall mirror dimensions before proceeding to installation.

\*All dimensions & specifications are approximate and subject to change without notice.

# LED MIRROR INSTALLATION GUIDE





## ELECTRIC CONNECTIONS

**ALL WIRING SHOULD BE DONE BY A QUALIFIED LICENCED ELECTRICIAN**

 **WARNING:** Shut off power before wiring the mirror.

 **WARNING:** An Electrical option mirror must be wired to a 20 Amp GFI(Ground Fault Interrupter) protected circuit when used in bathrooms and all other locations required by the National Electric Code.

 **WARNING:** This mirror must connect to a grounded metal permanent wiring system or an equipment-grounding conductor must run with the circuit conductors and connect to the equipment-grounding terminal or lead on the mirror.

 **CAUTION:** Requires 120 VAC 20 Amp GFI protected circuit.

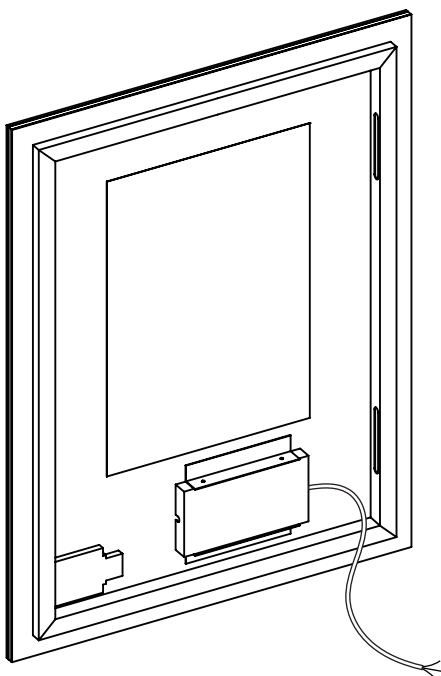

**Electric wiring:** Be sure to provide enough wire to make the proper and safe connection to the Field/Power.

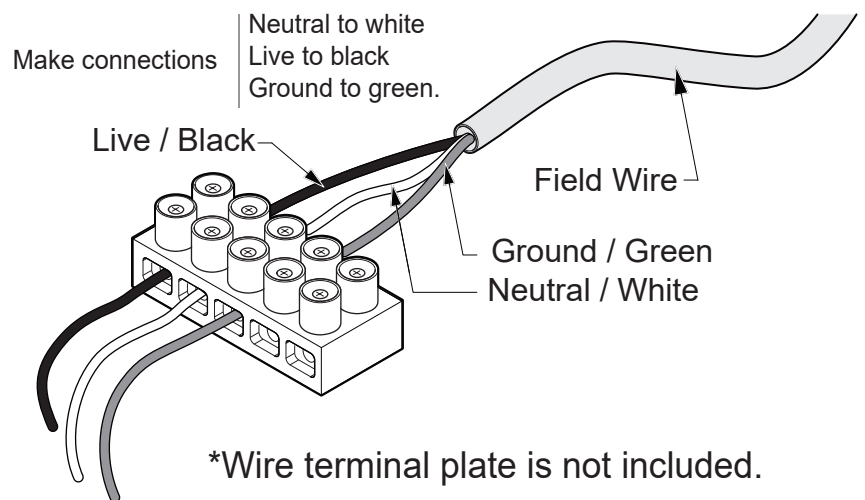

### MIRROR FEATURES

- 5mm copper free silver mirror
- High output LED lighting:  
CRI 90+, 2700-6500K CCT, IP44
- Color Temperature changing touch switch  
for surface LED
- Defogger

# INSTALLATION INSTRUCTIONS

## 1 PLACEMENT

Select the desired position of the mirror.  
Mark the curve at the top of the mirror.

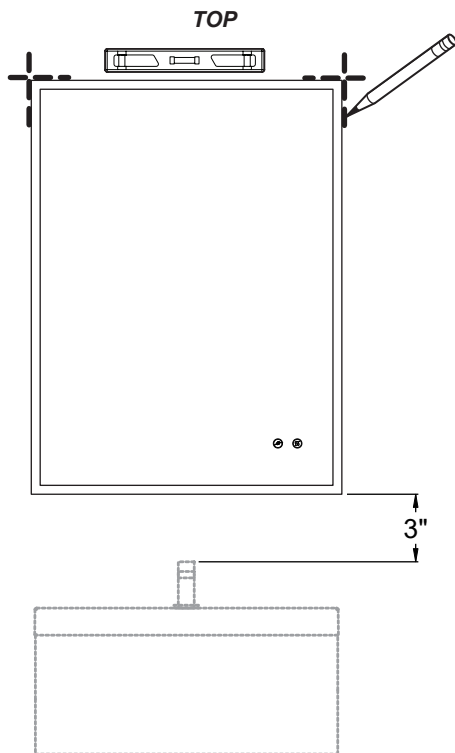

## 2 SUPPORT LOCATION

Measure the center of the holes and mark the drilling locations to ensure markings are leveled.

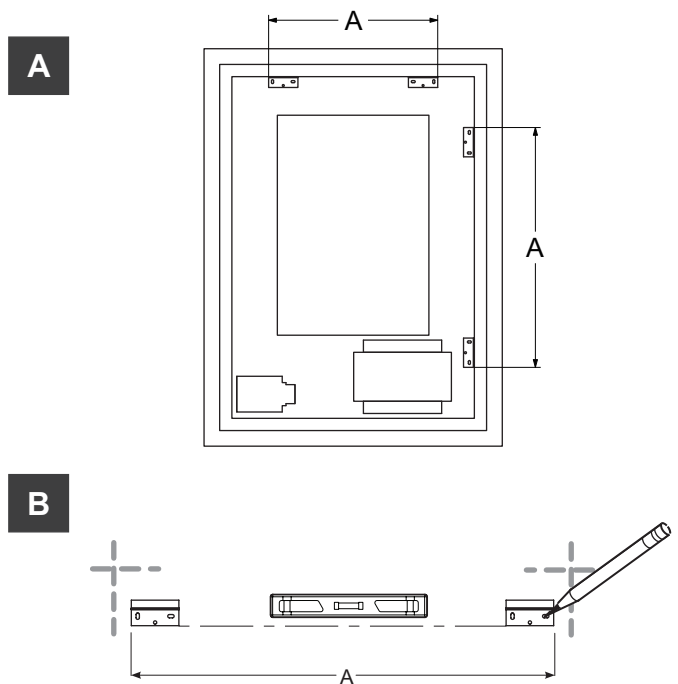

## 3 INSTALL SCREWS

Make holes with a drill and fill them with the supplied plugs and screws. Leave a gap of 2-3mm between the head of the screw and the wall.

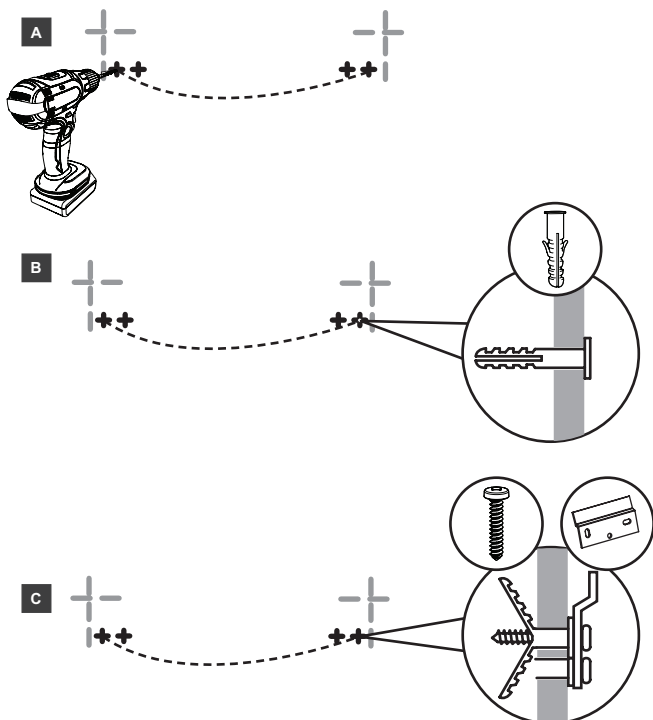

## 4 PLACEMENT

Hang the mirror onto the wall.

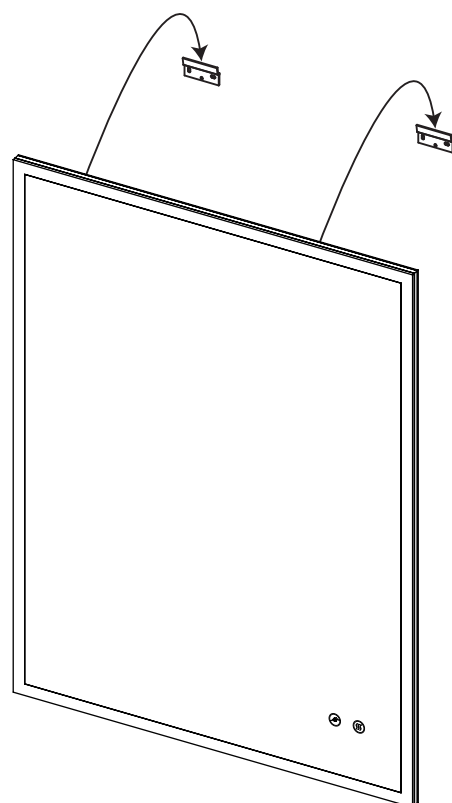

## FINAL ASSEMBLY

### How to use Defogger Switch and Dimmer Switch:

#### Single button touch switch

Touch  to turn the task light and defogger on or off.

Press and hold  to change the color temperature of the task light.

#### Double buttons touch switch

Touch  to turn the task light on or off.

Touch  to turn the defogger on or off.

Press and hold  to change the color temperature of the task light.

Press and hold  to dim or brighten the task light.

#### 3 buttons touch switch

Touch  to turn the task light on or off.

Touch  to cycle color temperature.

Press and hold  to change the color temperature of the task light.

Touch  to turn the defogger on or off.

Press and hold  to dim or brighten the task light.